

---

Assembly Instructions

Instructions d'assemblage

Instrucciones de ensamblado

組み立てプラン付き

---



---

Before beginning, review these instructions completely.

Always check local building codes.

Select roof and trim materials, and door hardware, (not included in Material List) if desired.

T-Hinge recommended for door. Other types of hinges may require modification to door width.

---

---

Avant de commencer, bien lire au complet ces instructions.

Toujours vérifier les codes locaux du bâtiment.

Sélectionner les matériaux de toit et de garniture, et la quincaillerie de porte, (non compris dans la Liste des matériaux) si désiré.

Charnières en T recommandées pour la porte. D'autres types de charnières peuvent nécessiter une modification à la largeur de la porte.

---

---

Antes de empezar, lea estas instrucciones completamente.

Siempre verifique los códigos de construcción locales.

Seleccione los materiales para el techo y el borde, y la herrajería para puertas (no incluida en la lista de materiales), si lo desea.

Se recomienda bisagra en T para la puerta. Otros tipos de bisagra pueden requerir modificación del ancho de la puerta.

---

---

始める前に、この説明書をすべてお読みください。

お住まいの地域の建築基準法を必ず確認してください。

材料リストには載っていない屋根材やトリム（装飾）、そしてドア金具などをお好みで選択してください。

ドアにはT型のちょうつがいをお勧めします。その他のちょうつがいは、ドアの幅を調節する必要があることがあります。

---

7 ft. x 8 ft.  
[2134 mm x 2438 mm]

8 ft. x 14 ft.  
[2438 mm x 4267 mm]

10 ft. x 22 ft.  
[3048 mm x 6706 mm]

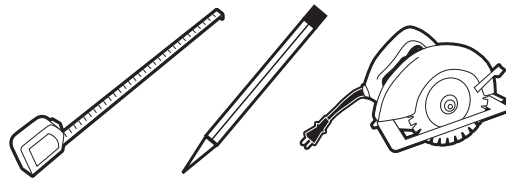

1x4 x 8 ft.  
[19 mm x 89 mm x 2438 mm]

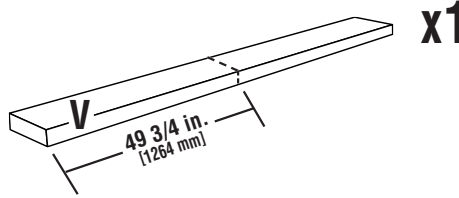

1x4 x 12 ft.  
[19 mm x 89 mm x 3658 mm]

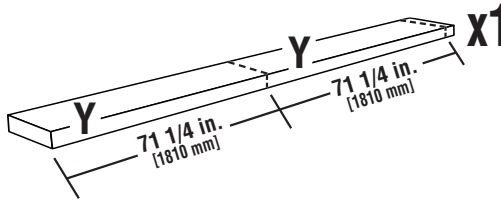

2x4 x 10 ft.  
[38 mm x 89 mm x 3048 mm]

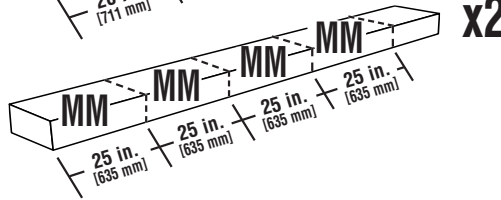
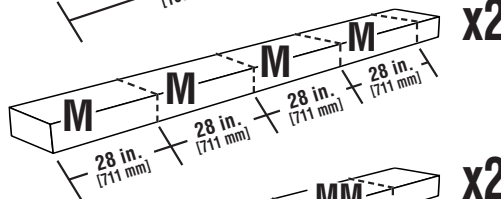
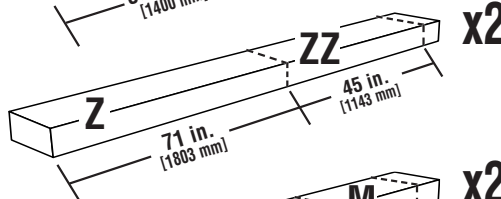
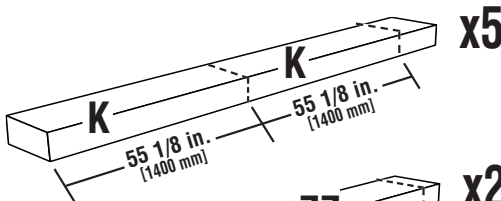

2x4 x 12 ft.  
[38 mm x 89 mm x 3658 mm]

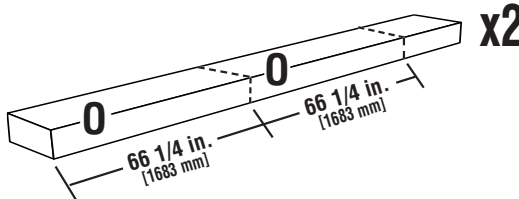

2x4 x 8 ft.  
[38 mm x 89 mm x 2438 mm]

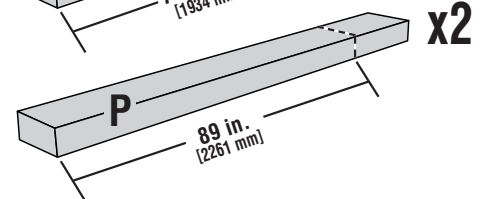
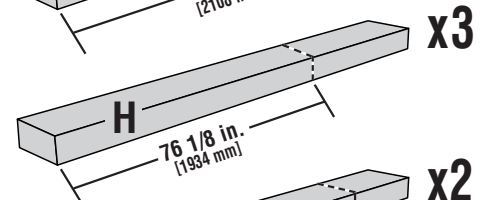
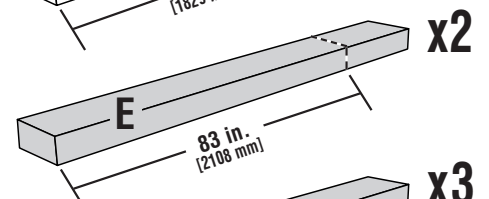
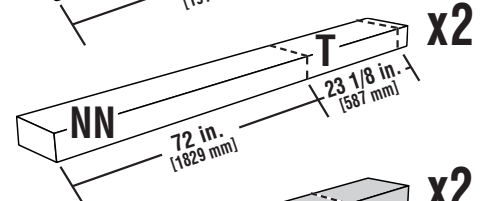
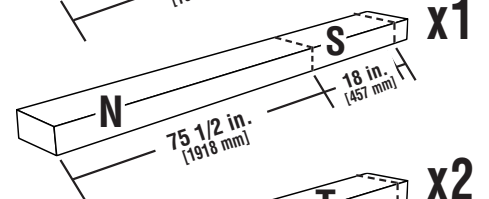
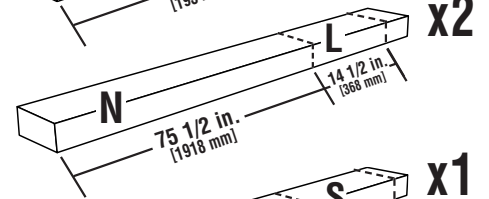
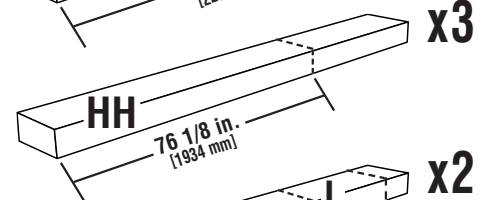
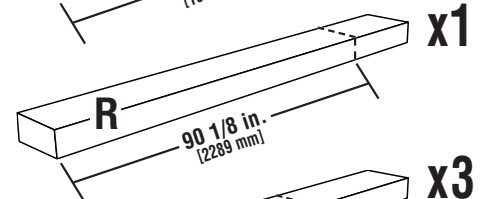
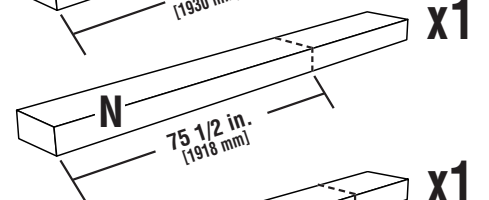
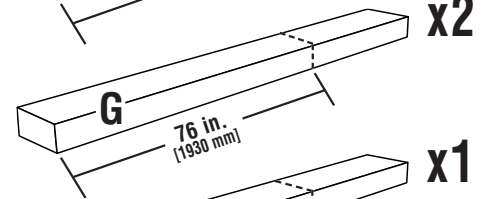

1 1/4 in. [32 mm] 3 lbs. [1.4 kg]

2 1/2 in. [64 mm] 3 lbs. [1.4 kg]

Pressure-treated  
= Traité sous pression  
Tratado de presión  
加压注入

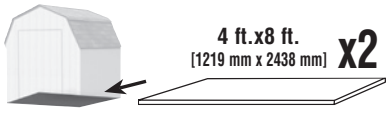
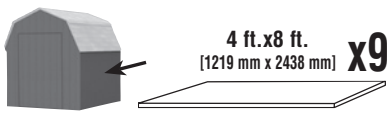
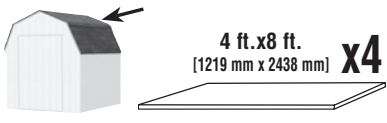
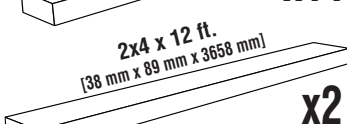
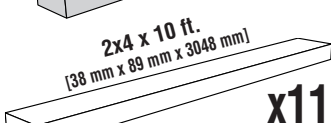
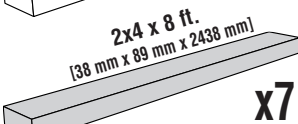
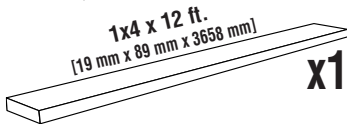
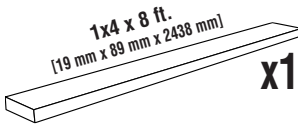

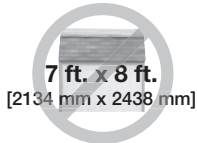

7 ft. x 8 ft.  
[2134 mm x 2438 mm]

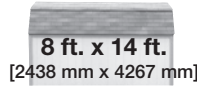

8 ft. x 14 ft.  
[2438 mm x 4267 mm]

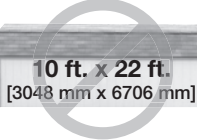

10 ft. x 22 ft.  
[3048 mm x 6706 mm]

1 1/4 in. [32 mm] **3 lbs.** [1.4 kg]

2 1/2 in. [64 mm] **3 lbs.** [1.4 kg]

= Pressure-treated  
Traité sous pression  
Tratado de presión  
加圧注入



1x4 x 8 ft.  
[19 mm x 89 mm x 2438 mm] **x1**

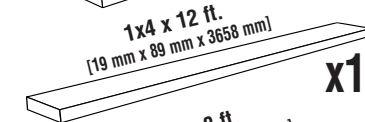

1x4 x 12 ft.  
[19 mm x 89 mm x 3658 mm] **x1**



2x4 x 8 ft.  
[38 mm x 89 mm x 2438 mm] **x26**

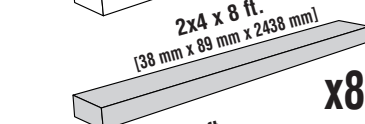

2x4 x 8 ft.  
[38 mm x 89 mm x 2438 mm] **x8**

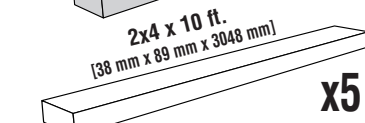

2x4 x 10 ft.  
[38 mm x 89 mm x 3048 mm] **x5**

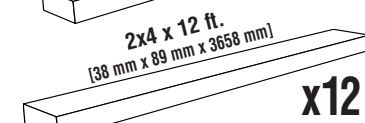

2x4 x 12 ft.  
[38 mm x 89 mm x 3658 mm] **x12**

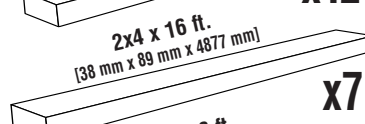

2x4 x 16 ft.  
[38 mm x 89 mm x 4877 mm] **x7**

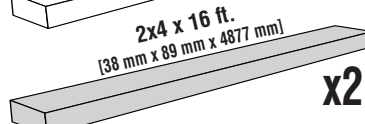

2x4 x 16 ft.  
[38 mm x 89 mm x 4877 mm] **x2**

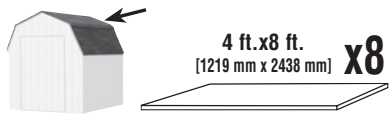

4 ft. x 8 ft.  
[1219 mm x 2438 mm] **x8**

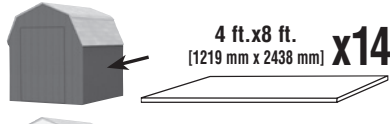

4 ft. x 8 ft.  
[1219 mm x 2438 mm] **x14**

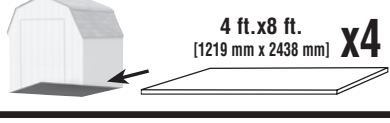

4 ft. x 8 ft.  
[1219 mm x 2438 mm] **x4**

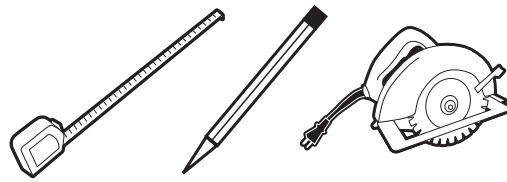

1x4 x 12 ft.  
[19 mm x 89 mm x 3658 mm]

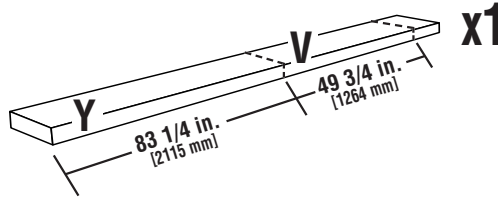

2x4 x 10 ft.  
[38 mm x 89 mm x 3048 mm]

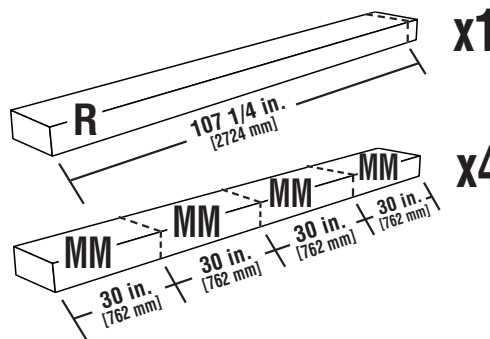

2x4 x 12 ft.  
[38 mm x 89 mm x 3658 mm]

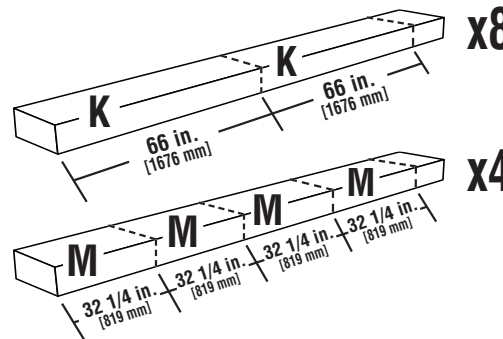

2x4 x 16 ft.  
[38 mm x 89 mm x 4877 mm]

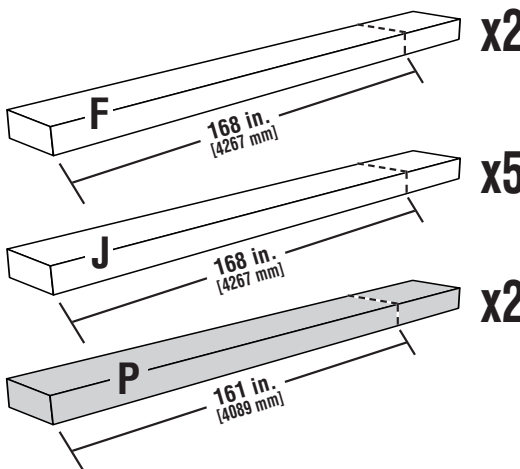

1x4 x 8 ft.  
[19 mm x 89 mm x 2438 mm]

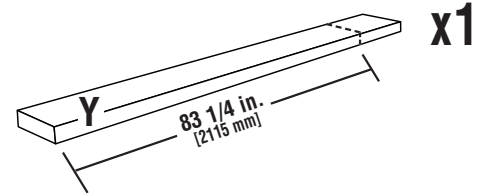

2x4 x 8 ft.  
[38 mm x 89 mm x 2438 mm]

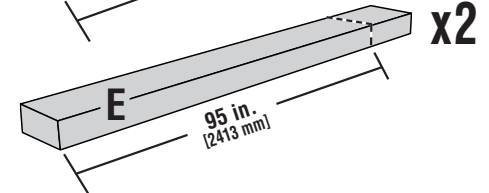
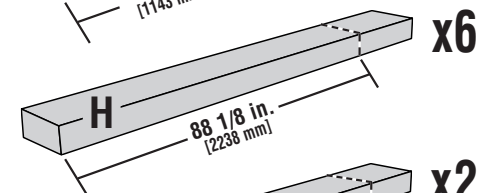
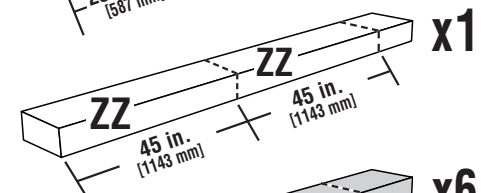
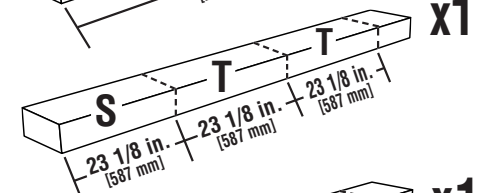
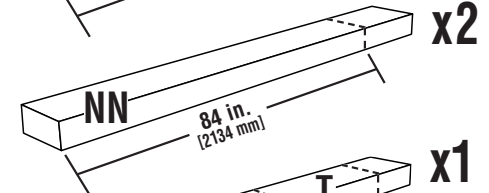
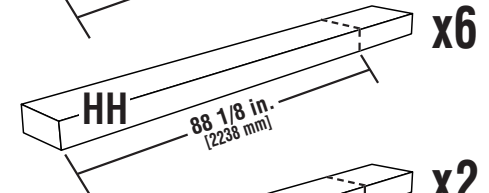
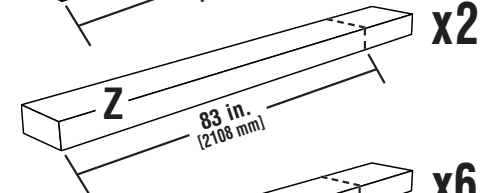
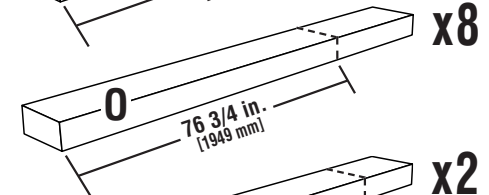
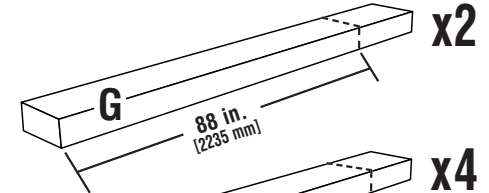

7 ft. x 8 ft.

[2134 mm x 2438 mm]

8 ft. x 14 ft.

[2438 mm x 4267 mm]

10 ft. x 22 ft.

[3048 mm x 6706 mm]

1 1/4 in.

[32 mm]



5 lbs.

[2.3 kg]

2 1/2 in.

[64 mm]



5 lbs.

[2.3 kg]

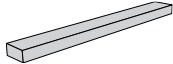
 = Pressure-treated  
Traité sous pression  
Tratado de presión  
加压注入

1x4 x 8 ft.

[19 mm x 89 mm x 2438 mm]

x1

1x4 x 10 ft.

[19 mm x 89 mm x 3048 mm]

x2

2x4 x 8 ft.

[38 mm x 89 mm x 2438 mm]

x47

2x4 x 10 ft.

[38 mm x 89 mm x 3048 mm]

x36

2x4 x 10 ft.

[38 mm x 89 mm x 3048 mm]

x10

2x4 x 12 ft.

[38 mm x 89 mm x 3658 mm]

x3

2x4 x 16 ft.

[38 mm x 89 mm x 4877 mm]

x8

2x4 x 16 ft.

[38 mm x 89 mm x 4877 mm]

x4



4 ft. x 8 ft.

[1219 mm x 2438 mm]

x12



4 ft. x 8 ft.

[1219 mm x 2438 mm]

x17



4 ft. x 8 ft.

[1219 mm x 2438 mm]

x7

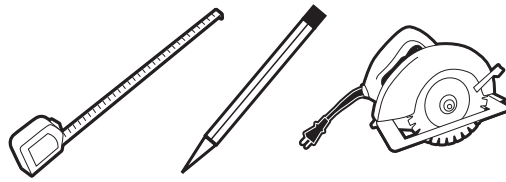

1x4 x 8 ft.

[19 mm x 89 mm x 2438 mm]

x1

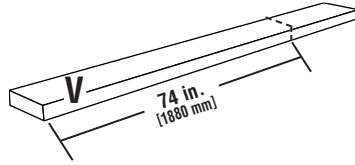

1x4 x 10 ft.

[19 mm x 89 mm x 3048 mm]

x2

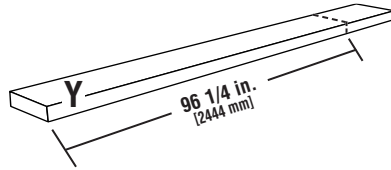

2x4 x 12 ft.

[38 mm x 89 mm x 3658 mm]

x1

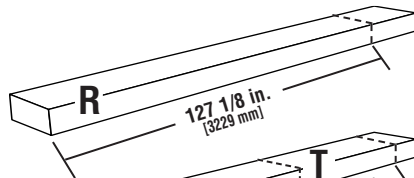

x2

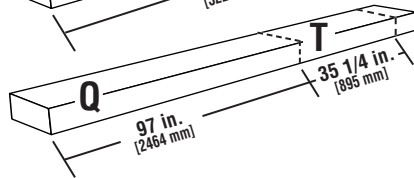

2x4 x 16 ft.

[38 mm x 89 mm x 4877 mm]

x2

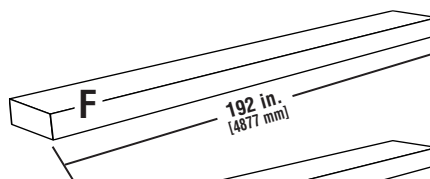

x5



x1

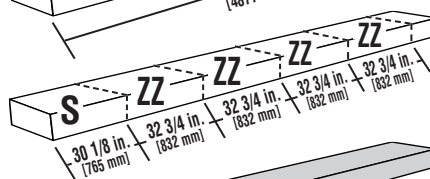

x2

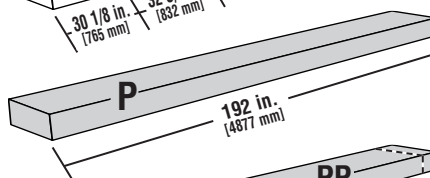

x2

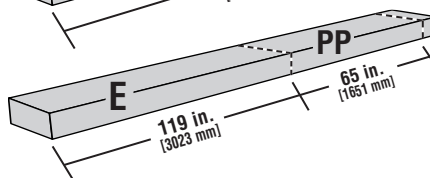

2x4 x 8 ft.

[38 mm x 89 mm x 2438 mm]

x12

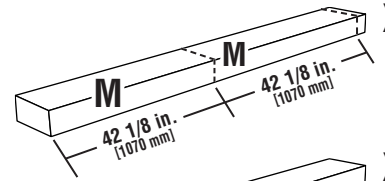

x4



x24



x2

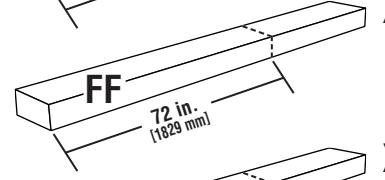

x5

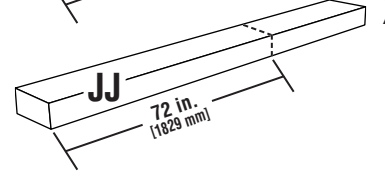

2x4 x 10 ft.

[38 mm x 89 mm x 3048 mm]

x2

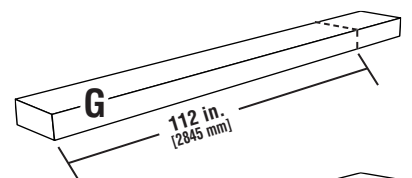

x4

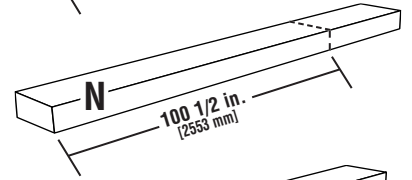

x12

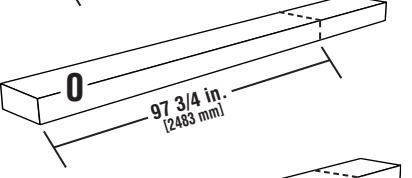

x10

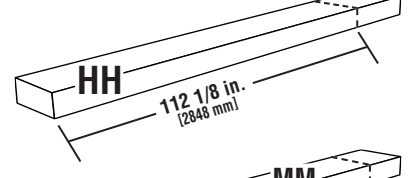

x8

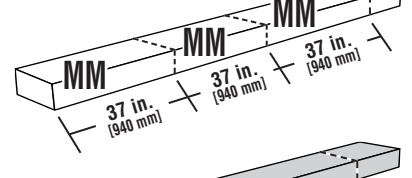

x10

